

LG-03IR4C94C-302BA

DATA SHEET

SPEC. NO. : SZ18080401
DATE : 2020/07/23
REV. : A/4

Approved By:

Checked By:

Prepared By:

Features

- ◆ Pb free product—RoHS compliant
- ◆ Low power consumption, High efficiency
- ◆ General purpose leads
- ◆ Reliable and rugged
- ◆ Long life – solid state reliability
- ◆ Radiant angle: 30 °

Package Dimension

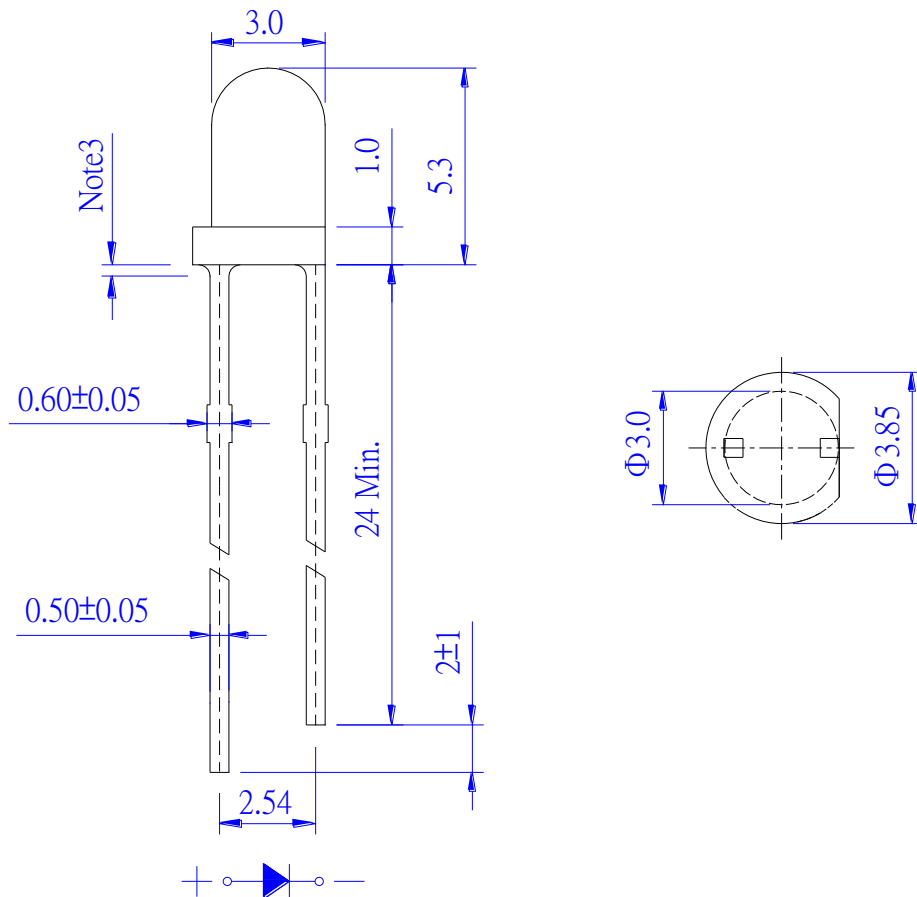

Part NO.	Chip Material	Lens Color
LG-03IR4C94C-302BA	AlGaAs	Water Clear

Notes:

1. All dimensions are in millimeters.
2. Tolerance is ±0.20mm unless otherwise noted.
3. Protruded resin under flange is 1.0mm max.
4. Lead spacing is measured where the leads emerge from the package.
5. Specifications are subject to change without notice.

Absolute Maximum Ratings at Ta=25°C

Parameter	MAX.	Unit
Power Dissipation	150	mW
Continuous Forward Current	100	mA
Peak Forward Current*3	1.0	A
Reverse Voltage	5	V
Operating Temperature	-40°C to + 85°C	
Storage Temperature	-40°C to + 100°C	
Lead Soldering Temperature [2mm From Body]	260°C for 3 Seconds	
Lead Soldering Temperature [5mm From Body]	260°C for 5 Seconds	

1. Storage:

The storage ambient for the LEDs should not exceed 30 °C temperature or 70% relative humidity.

It is recommended that LEDs out of their original packaging are used within three months.

For extended storage out of their original packaging, it is recommended that the LEDs be stored in a sealed container with appropriate desiccant or in desiccators with nitrogen ambient.

2. Precautions in handling:

- When soldering, leave 2mm of minimum clearance from the resin to the soldering point.
- Dipping the resin to solder must be avoided.
- Correcting the soldered position after soldering must be avoided.
- In soldering, do not apply any stress to the lead frame particularly when heated.
- When forming a lead, make sure not to apply any stress inside the resin.
- Lead forming must be done before soldering.
- It is necessary to cut the lead frame at normal temperature.

3. Peak Forward Current:

Condition for is IFP pulse: Pulse Width ≤ 0.1ms and duty ≤ 1%.

Electrical Optical Characteristics at Ta=25°C

Parameter	Symbol	Min.	Typ.	Max.	Unit	Test Condition
Radiant Intensity	I _e	25	35	51.8	mW/sr	I _F =50mA (Note 1,3)
Viewing Angle	2θ _{1/2}	25	30	35	Deg.	(Note 2)
Peak Wavelength	λ _p	---	940	---	nm	I _F =20mA
Spectral Line Half- Width	Δλ	---	50	---	nm	I _F =20mA
Forward Voltage	V _F	---	1.25	1.5	V	I _F =50mA
Reverse Current	I _R	---	---	100	μA	V _R =5V

Note:

1. Point sources of the amount of radiation per unit time in a given direction within the unit solid Angle radiated energy.
2. θ_{1/2} is the off-axis angle at which the Radiant Intensity is half the axial Radiant Intensity.
3. The I_e guarantee should be added ±15% tolerance.

Recommended Wave Soldering Profile

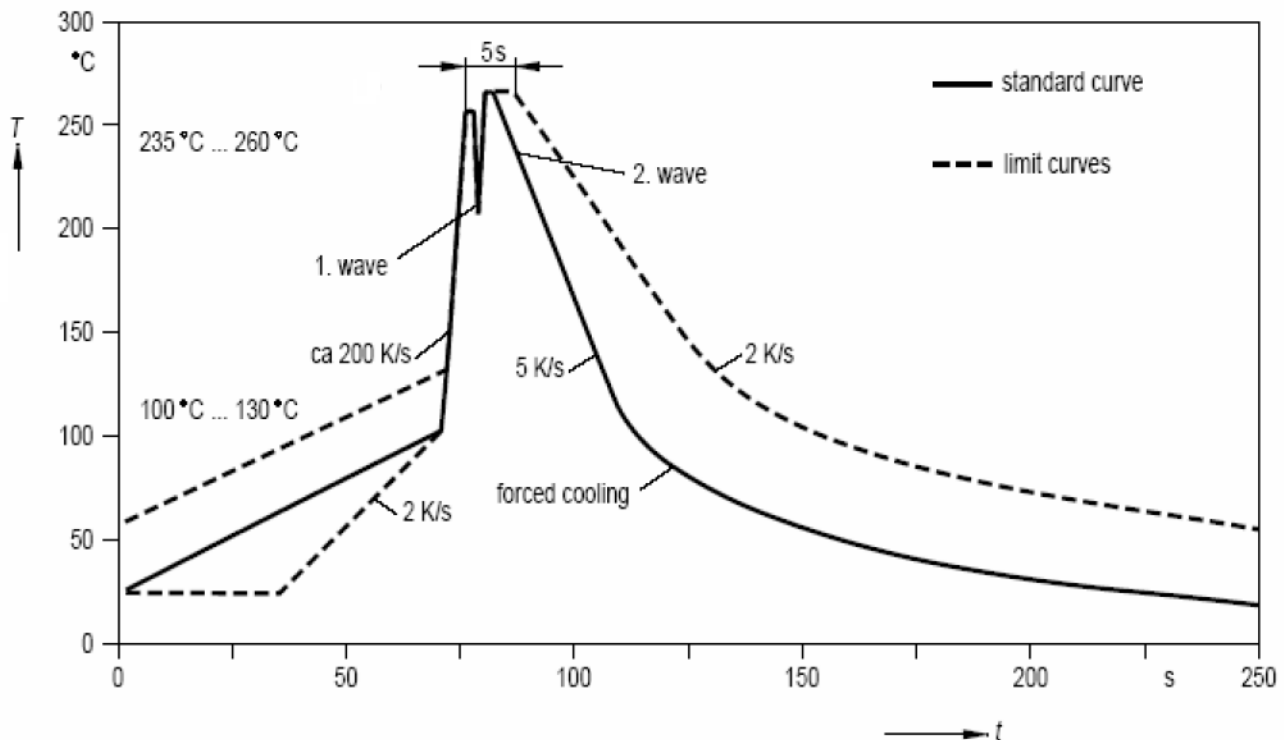

Typical Electrical / Optical Characteristics Curves (25°C Ambient Temperature Unless Otherwise Noted)

Fig.1 Spectral Distribution

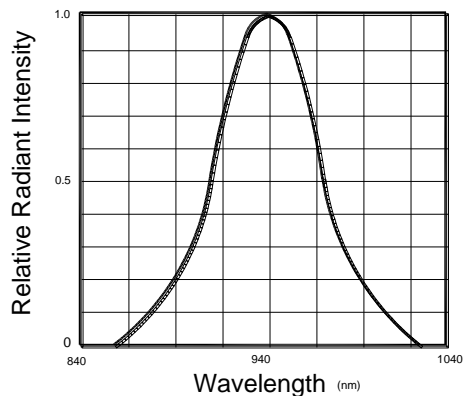

Fig.2 Forward constant current I_F (mA) Vs Ambient Temperature

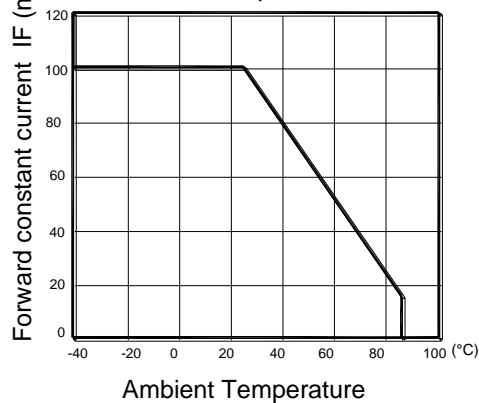

Fig.3 Forward Current Vs Forward Voltage

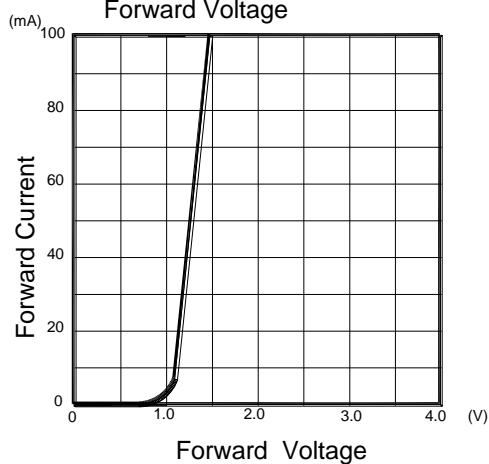

Fig.4 Relative Radiant Intensity Vs Ambient Temperature @ $I_F=50\text{mA}$

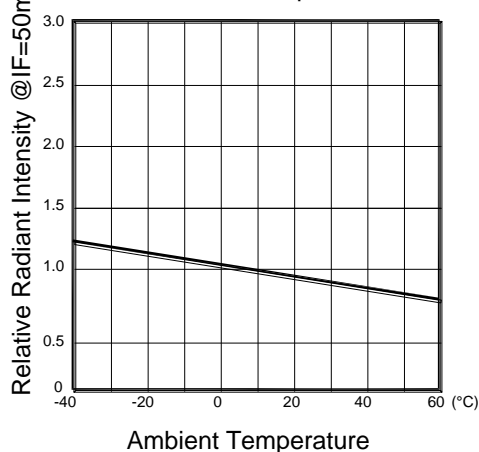

Fig.5 Relative Radiant Intensity Vs Forward Current @ $I_F=50\text{mA}$

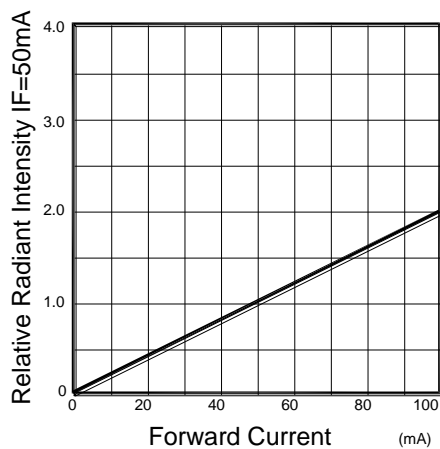
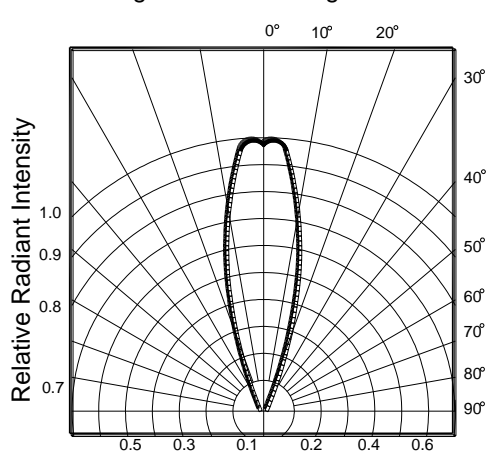

Fig.6 Radiation Diagram



LED MOUNTING METHOD

1. The lead pitch of the LED must match the pitch of the mounting holes on the PCB during component placement. Lead-forming may be required to insure the lead pitch matches the hole pitch. Refer to the figure below for proper lead forming procedures (Fig.1).

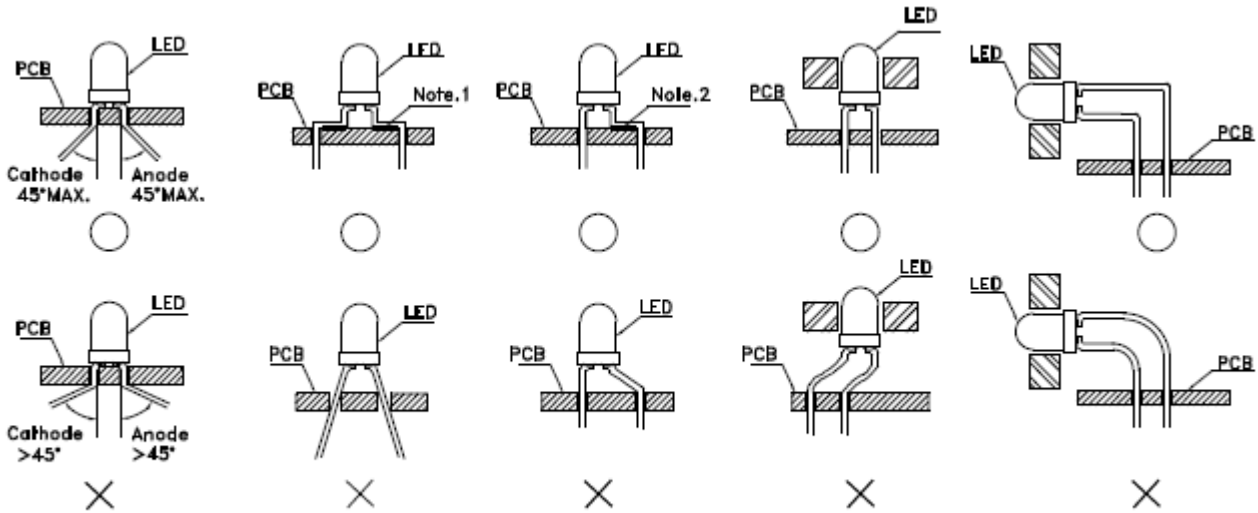

Fig. 1

“o” Correct mounting method “x” Incorrect mounting method

Note 1-2: Do not route PCB trace in the contact area between the lead frame and the PCB to prevent short-circuits.

2. When soldering wire to the LED, use individual heat-shrink tubing to insulate the exposed leads to prevent accidental contact short-circuit (Fig.2).

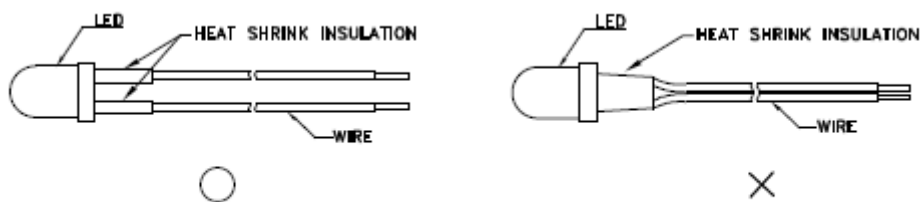

Fig. 2

3. Use stand-offs (Fig.3) or spacers (Fig.4) to securely position the LED above the PCB.

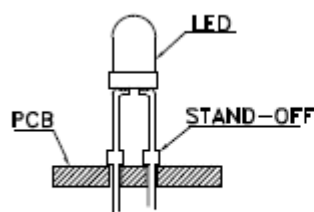

Fig. 3

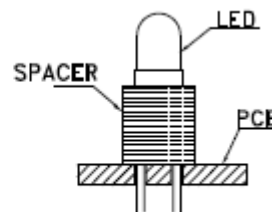

Fig. 4

LEAD FORMING PROCEDURES

1. Maintain a minimum of 2mm clearance between the base of the LED lens and the first lead bend (Fig.5 and Fig.6).

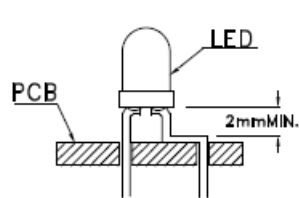

Fig. 5

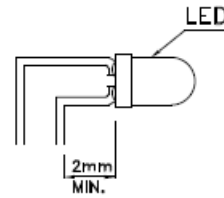

Fig. 6

2. Lead forming or bending must be performed before soldering, never during or after soldering.

3. Do not stress the LED lens during lead-forming in order to fractures in the lens epoxy and damage the internal structures.

4. During lead forming, use tools or jigs to hold the leads securely so that the bending force will not be transmitted to the LED lens and its internal structures. Do not perform lead forming once the component has been mounted onto the PCB (Fig.7).

5. Do not bend the leads more than twice(Fig.8)

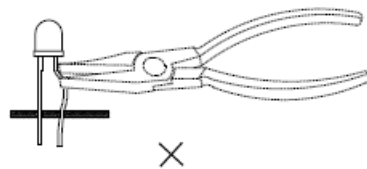

Fig. 7

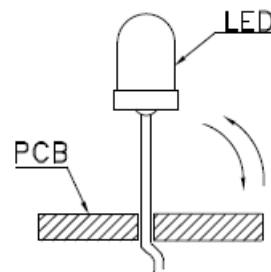

Fig. 8

6. After soldering or other high-temperature assembly, allow the LED to cool down to 50 °C before applying force (Fig.9).In general, avoid placing excess force on the LED to avoid damage. For any questions please consult with LIGHT representative for proper handling procedures.

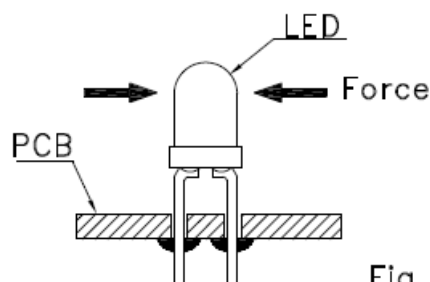
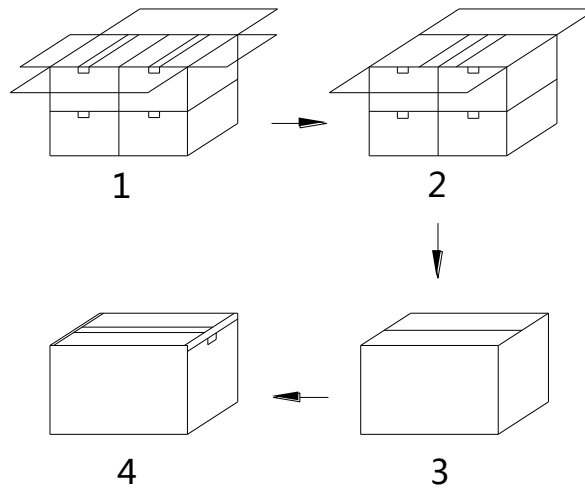
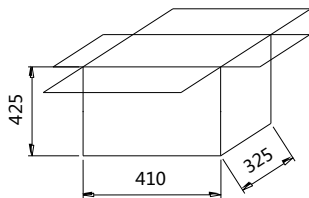
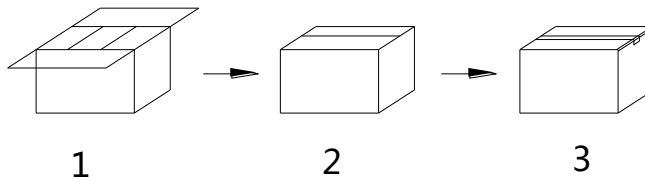
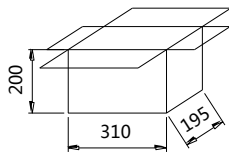
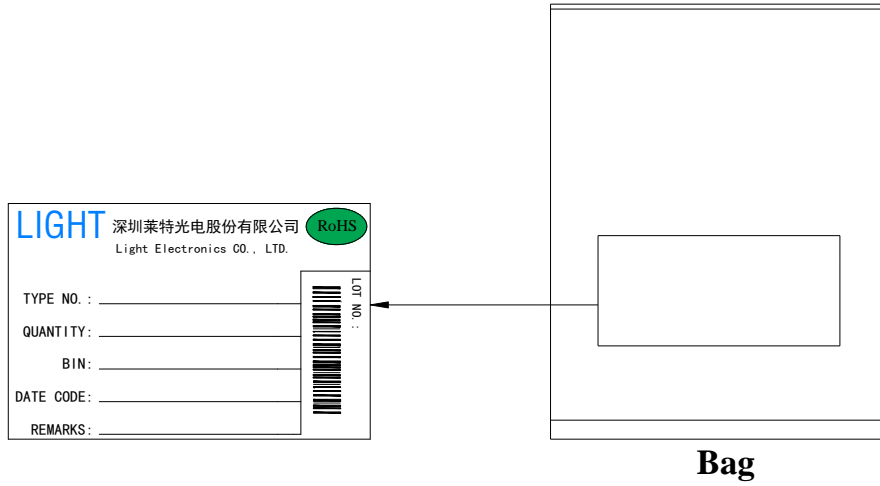

Fig. 9

PACKAGE



Bag minimum volume (pcs / Bag)	Bag volume (pcs / Bag)	Inner box volume (Bag / box)	Outer carton volume (Box / Carton)
250	1000	10	4

Radiant Intensity Bin Code (IF=50mA)

BIN CODE	Min. (mW/sr)	Max. (mW/sr)
4	25	30
5-A	30	32.9
5-B	32.9	35.2
6	35.2	43.2
7	43.2	51.8

NOTE: The I_e guarantee should be added $\pm 15\%$ tolerance.