

LG-05PD4D94K-5118H

PHOTO Diode

DATA SHEET

SPEC. NO. : SZ19042002
DATE : 2019/04/20
Version No. : A3

Approved By:

Checked By:

Prepared By:

Features

- ◆ Pb free product—RoHS compliant 无 Pb 产品，符合 ROHS 要求
- ◆ High Photo Sensitivity 高灵敏度
- ◆ General purpose leads 通用性好
- ◆ Reliable and rugged 可靠性好、坚固
- ◆ Long life – solid state reliability 寿命长

Package Dimension

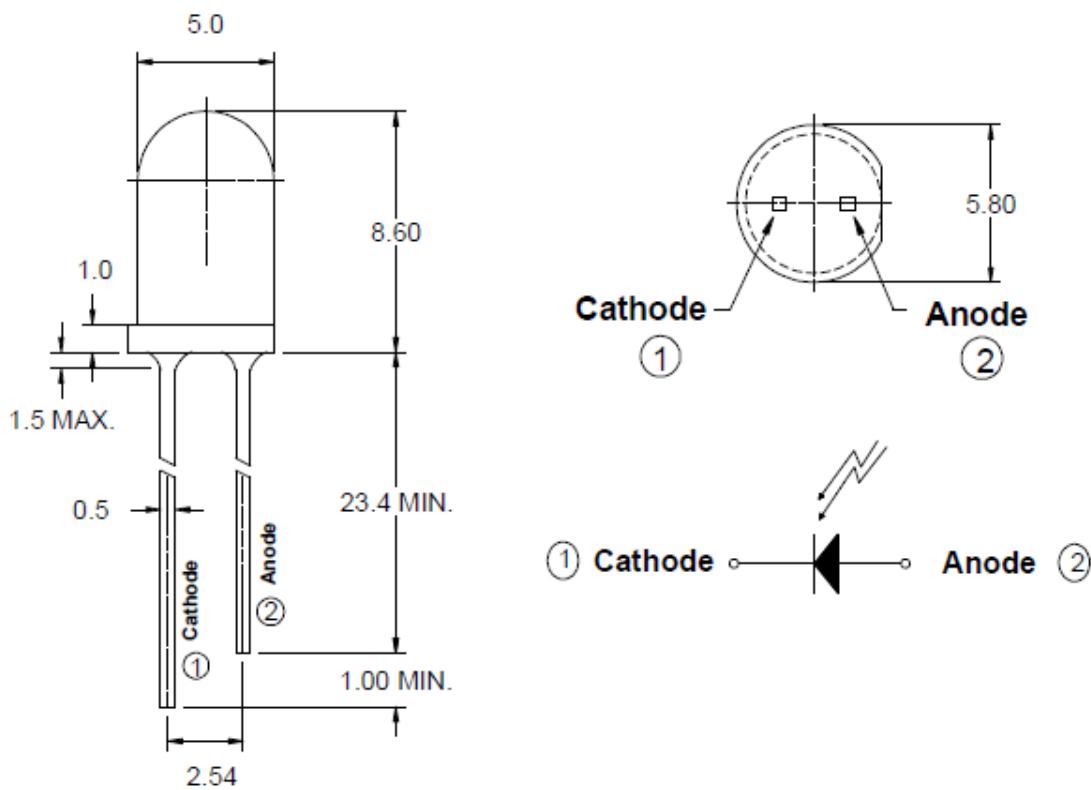

Part NO.产品型号	Chip Material 晶片材质	Lens Color 胶体颜色
LG-05PD4D94K-5118H	Silicon	Black

Notes:

1. All dimensions are in millimeters.
所有尺寸单位为：毫米。
2. Tolerance is $\pm 0.20\text{mm}$ unless otherwise noted.
尺寸未标示公差部分的尺寸公差为 ± 0.2 毫米。

Absolute Maximum Ratings at Ta=25°C

Parameter 参数	Maximum Rating 最大值	Unit 单位
Power Dissipation 耗散功率	100	mW
Reverse Voltage 反向电压	30	V
Operating Temperature 操作温度	-40°C ~ +85°C	
Storage Temperature Range 存储温度	-45°C ~ +100°C	
Wave Soldering Condition 波峰焊条件	260°C for 5 seconds	

1. Storage: 存储

The storage ambient for the LEDs should not exceed 70% relative humidity.

LED 灯存储环境湿度不得超过 70%。

It is recommended that LEDs out of their original packaging are used within three months.

建议 LED 不开封情况下在三个月内使用。

It is recommended that LED be used in 168hrs after opening the package, If extended, use 70±5°C before baking more than 12hrs

建议 LED 在开封后 168hrs 使用完成，若超时，使用前需使用 70±5°C 温度烘烤除湿 12hrs 以上。

2. Precautions in handling: 预防措施处理

- When soldering, leave 1mm of minimum clearance from the resin to the soldering point.
焊接时，尽可能使胶体与支架之间的长度大于 1mm。
- Dipping the resin to solder must be avoided.
不得将胶体浸泡在锡炉中。
- In soldering, do not apply any stress to the lead frame particularly when heated.
在高温焊接时，避免对支架施加外力。
- When forming a lead, make sure not to apply any stress inside the resin.
在高温焊接时，避免对胶体施加外力。

Electrical Optical Characteristics at Ta=25°C

PARAMETER 参数	SYMBOL 符号	MIN 最小值	TYP 典型值	MAX 最大值	UNITS 单位	TEST CONDITIONS 测试条件
Reverse Light Current 光电流	I_L	-	85	-	μA	$V_R=5\text{V}, E_e=1\text{mW}/\text{cm}^2$
Reverse Dark Current 暗电流	I_D	-	-	100	nA	$V_R=10\text{V}, E_e=0\text{mW}/\text{cm}^2$
Reverse Voltage 反向电压	$V_{(R)}$	30	-	-	V	$I_R=100\mu\text{A}$
Forward Voltage 正向电压	V_F	-	-	1.3	V	$I_F=1\text{mA}$
Rise Time/ Fall Time 响应时间	tr/ tf	-	50	-	ns	$V_R=20\text{V}, R_L=50\Omega$
Total Capacitance 结电容	C_T	-	9	-	PF	$V_R=5\text{V}, E_e=0, f=1.0\text{MHZ}$
Viewing Angle 发光角度	$2\theta_{1/2}$	34	38	42	deg	(Note 2)

Note:

- $\theta_{1/2}$ is the off-axis angle at which the IL is half the axial IL.
半功率角度为光电流在 50% 的时候的夹角。
- The IL test error is based on our test.
光电流测试误差以敝司的测试作为标准。
- The IL guarantee should be added $\pm 15\%$ tolerance.
光电流测试公差为 $\pm 15\%$ 。

Suggest Wave Soldering Condition For Lead Free: 建议波峰焊曲线图

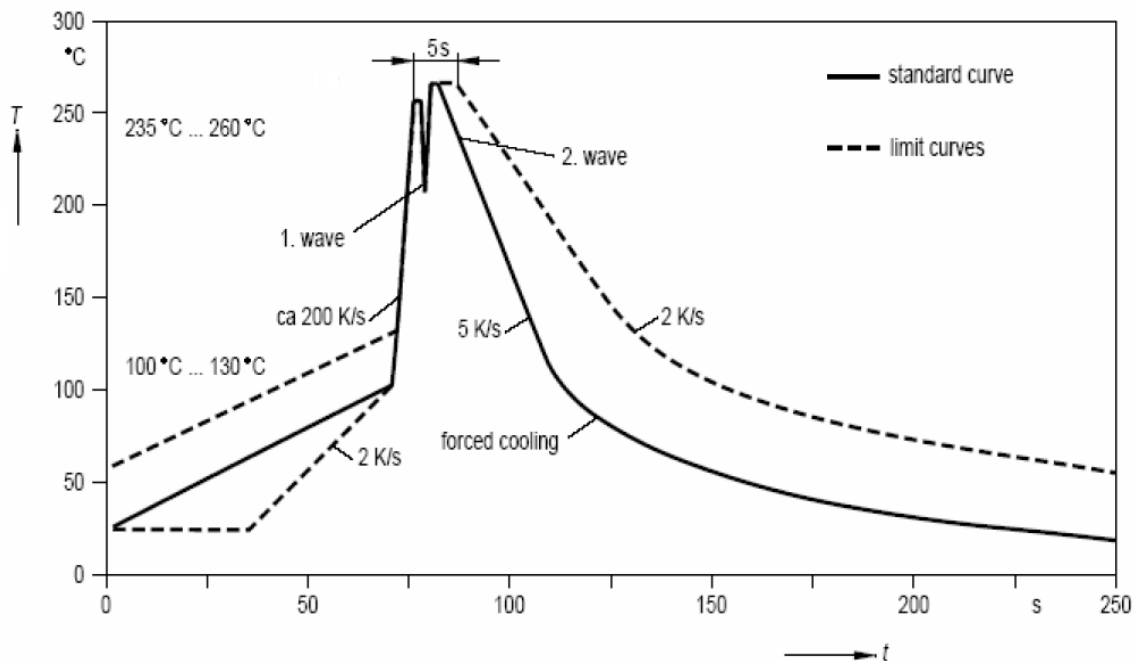

Typical Electrical / Optical Characteristics Curves 光电曲线图 (25°C Ambient Temperature Unless Otherwise Noted) 常温条件下

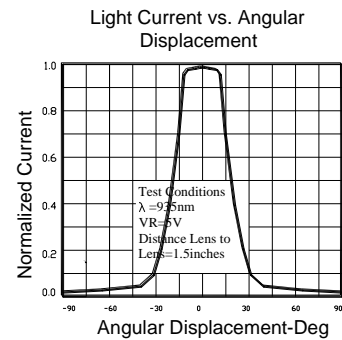
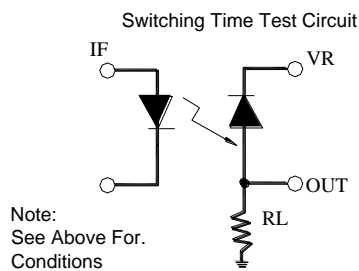
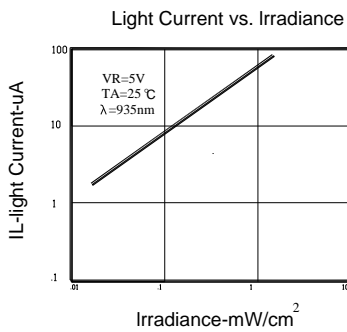
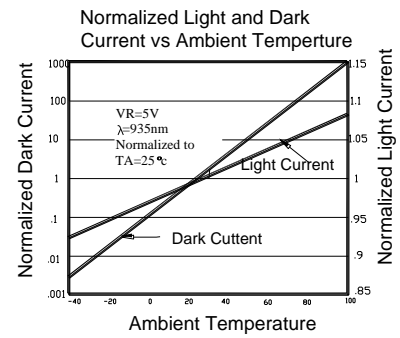
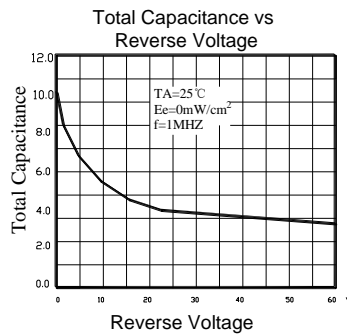
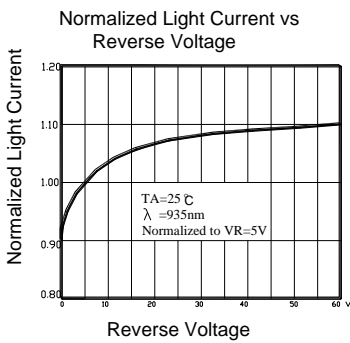
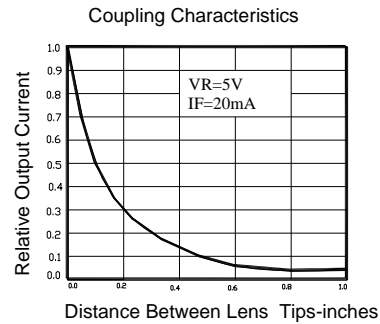
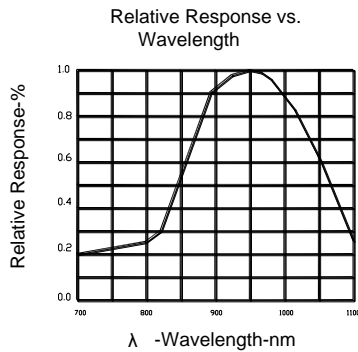

Infrared Photo Diode Specification

●Commodity: Infrared Photo diode

●Intensity Bin Limits

BIN CODE	Min.(uA)	Max.(uA)
6	65	88
7	88	110

LED MOUNTING METHOD

1. The lead pitch of the LED must match the pitch of the mounting holes on the PCB during component placement. Lead-forming may be required to insure the lead pitch matches the hole pitch. Refer to the figure below for proper lead forming procedures (Fig.1).

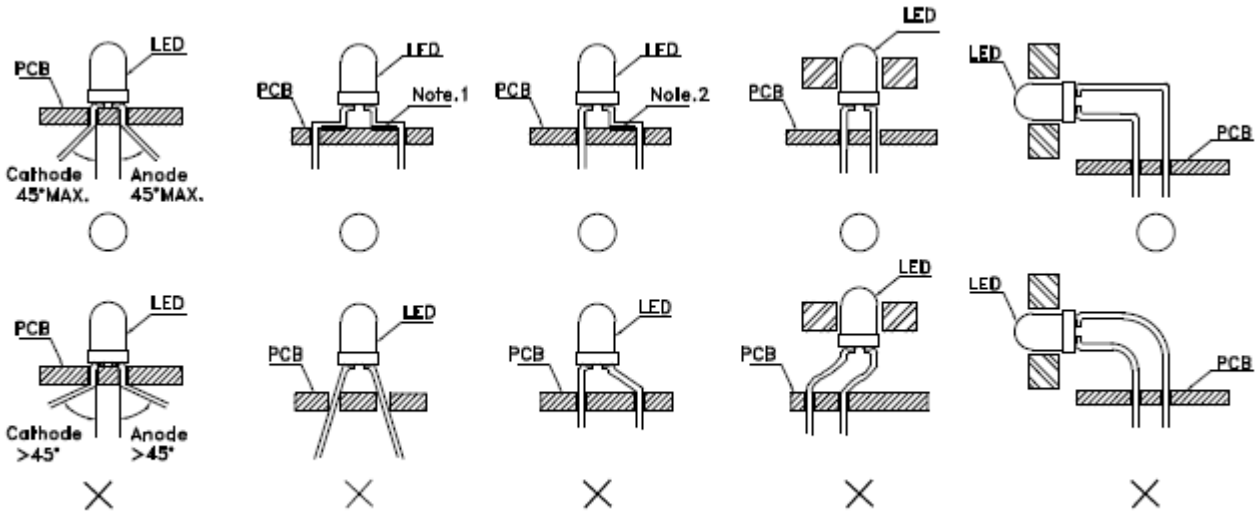

Fig. 1

“o” Correct mounting method “x” Incorrect mounting method

Note 1-2: Do not route PCB trace in the contact area between the lead frame and the PCB to prevent short-circuits.

2. When soldering wire to the LED, use individual heat-shrink tubing to insulate the exposed leads to prevent accidental contact short-circuit (Fig.2).

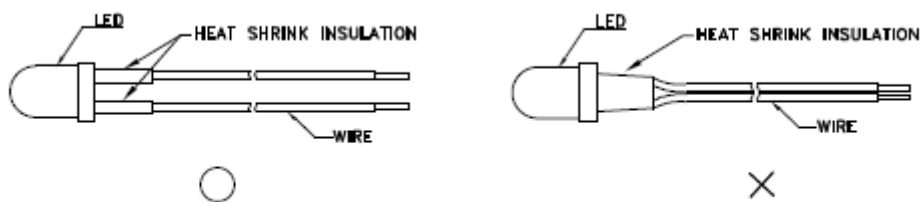

Fig. 2

3. Use stand-offs (Fig.3) or spacers (Fig.4) to securely position the LED above the PCB.

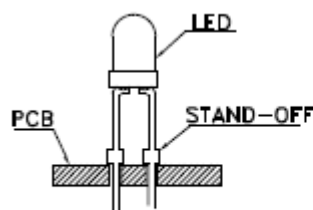

Fig. 3

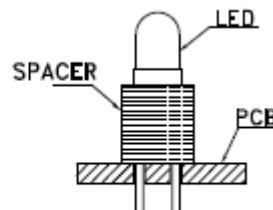

Fig. 4

LEAD FORMING PROCEDURES

1. Maintain a minimum of 2mm clearance between the base of the LED lens and the first lead bend (Fig.5 and Fig.6).

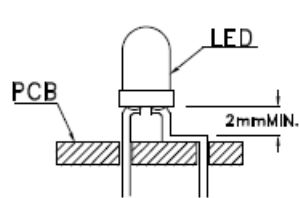

Fig. 5

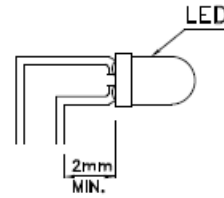

Fig. 6

2. Lead forming or bending must be performed before soldering, never during or after soldering.

3. Do not stress the LED lens during lead-forming in order to fractures in the lens epoxy and damage the internal structures.

4. During lead forming, use tools or jigs to hold the leads securely so that the bending force will not be transmitted to the LED lens and its internal structures. Do not perform lead forming once the component has been mounted onto the PCB (Fig.7).

5. Do not bend the leads more than twice(Fig.8)

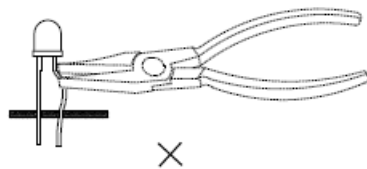

Fig. 7

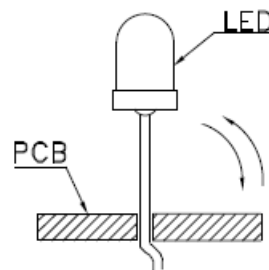

Fig. 8

6. After soldering or other high-temperature assembly, allow the LED to cool down to 50 °C before applying force (Fig.9).In general, avoid placing excess force on the LED to avoid damage. For any questions please consult with LIGHT representative for proper handling procedures.

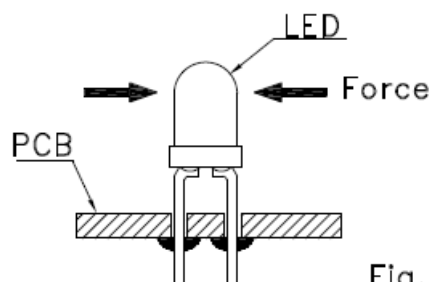
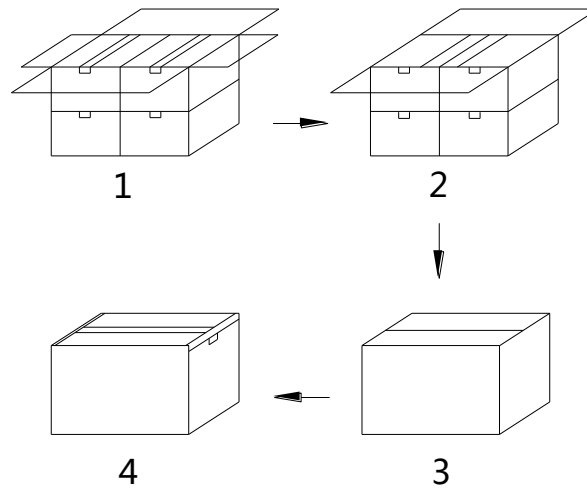
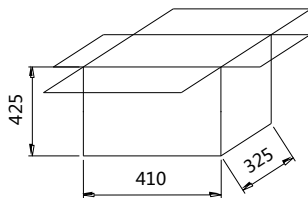
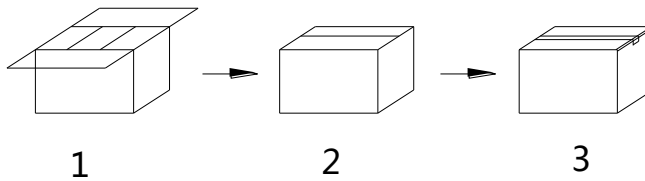
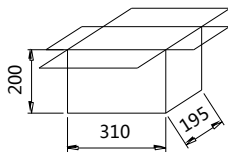
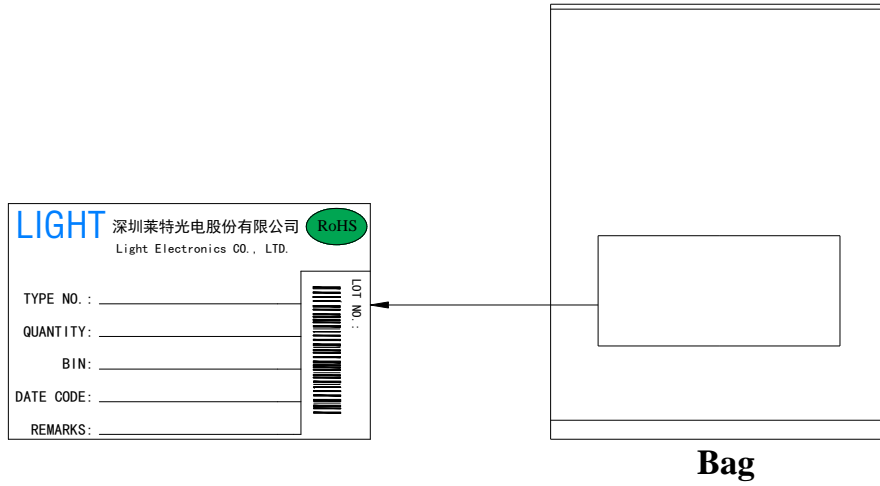

Fig. 9

PACKAGE



Bag minimum volume (pcs / Bag)	Bag volume (pcs / Bag)	Inner box volume (Bag / box)	Outer carton volume (Box / Carton)
500	1000	10	4